

Serial No.	H-V014-E-14
------------	-------------

Ball Check Valve
True Union Ball Check Valve
Ball Foot Valve

User's Manual





Contents



- (1) Be sure to read the following warranty clauses of our product 1
- (2) General operating instructions 2
- (3) General instructions for transportation, unpacking and storage 3
- (4) Name of parts 4
- (5) Working pressure vs. temperature 6
- (6) Installation procedure 7
- (7) Disassembling method for replacing parts 10
- (8) Inspection items 11
- (9) Troubleshooting 11
- (10) Handling of residual and waste materials 11

This user's guide contains very important information for the proper installation, maintenance and safe use of an ASAHI AV Product. Please store this manual in an easily accessible location.

<Warning & Caution Signs>

 Warning	This symbol reminds the user to take caution due to the potential for serious injury or death.
 Caution	This symbol reminds the user to take caution due to the potential for damage to the valve if used in such a manner.



<Prohibited & Mandatory Action Signs>



	Prohibited: When operating the valve, this symbol indicates an action that should not be taken.
	Mandatory action: When operating the valve, this symbol indicates mandatory actions that must be adhered to.

(1) Be sure to read the following warranty clauses of our product

- Always confirm the specifications of and the precautions and instructions on using our product.
- We always strive to improve product quality and reliability, but cannot guarantee perfection. Therefore, should you intend to use this product with any equipment or machinery that may pose the risk of serious or even fatal injury, or property damage, ensure an appropriate safety design or take other measures with sufficient consideration given to possible problems. We shall assume no responsibility for any inconvenience stemming from any action on your part without our written consent in the form of specifications or other documented approval.
- The related technical documents, operation manuals, and other documentation prescribe precautions on selecting, constructing, installing, operating, maintaining, and servicing our products. For details, consult with our nearest distributor or agent.
- Our product warranty extends for one and a half years after the product is shipped from our factory or one year after the product is installed, whichever comes first. Any product abnormality that occurs during the warranty period or which is reported to us will be investigated immediately to identify its cause. Should our product be deemed defective, we shall assume the responsibility to repair or replace it free of charge.
- Any repair or replacement needed after the warranty period ends shall be charged to the customer.
- The warranty does not cover the following cases:
 - (1) Using our product under any condition not covered by our defined scope of warranty.
 - (2) Failure to observe our defined precautions or instructions regarding the construction, installation, handling, maintenance, or servicing of our product.
 - (3) Any inconvenience caused by any product other than ours.
 - (4) Remodeling or otherwise modifying our product by anyone other than us.
 - (5) Using any part of our product for anything other than the intended use of the product.
 - (6) Any abnormality that occurs due to a natural disaster, accident, or other incident not stemming from something inside our product.



(2) General Operating Instructions

- 

Warning
 - Using a positive-pressure gas with our plastic piping may pose a hazard due to the repellent force particular to compressible fluids, even when the gas is under similar pressures used for liquids. Therefore, be sure to take the necessary safety precautions such as covering the piping with protective material. For inquiries, please contact us. For conducting a leak test on newly installed piping, be sure to check for leaks under water pressure. If absolutely necessary to use a gas in testing, please consult your nearest service station beforehand.

- 

Caution
 - Do not step on or apply excessive weight on valve. (It can be damaged.)
 - Avoid using the valve in a line where the fluid flow is turbulent. The ball may excessively bounce around, resulting in damage.
 - Do not use the valve to fluid containing slurry. (The valve will not operate properly.)
 - Do not use the valve in conditions where the fluid may have crystallized. (The valve will not operate properly.)

- 
 - Keep the valve away from excessive heat or fire. (It can be damaged, or destroyed.)
 - Always operate the valve within the pressure vs. temperature range. (The valve can be damaged or deformed by operating beyond the allowable range.)
 - Allow sufficient space for maintenance and inspection.
 - Select a valve material that is compatible with the media. For chemical resistance information, refer to “CHEMICAL RESISTANCE ON ASAHI AV VALVE”. (Some chemicals may damage incompatible valve materials.)
 - Keep the valve away from places of direct sunlight, water and dust. Use cover to shield the valve. (The valve will not operate properly.)
 - Perform regular maintenance. (Leakage may develop due to temperature changes or periods of prolonged storage, rest, or operation.)
 - Use the valve at a pressure exceeding the minimum operating differential pressure. (Check the effective head.)

(3) General instructions for transportation, unpacking and storage

- 

 - This valve is not designed to handle impacts of any kind. Avoid throwing or dropping the valve.
- Caution
 - Avoid scratching the valve with any sharp object.
 - Do not over-stack cardboard shipping boxes. Excessively stacked packages may collapse.
 - Avoid contact with any coal tar creosote, insecticides, vermicides or paint.
(These chemicals may cause damage to the valve.)
- 
 - Store products in their corrugated cardboard boxes. Avoid exposing products to direct sunlight, and store them indoors (at room temperature). Also avoid storing products in areas with excessive temperatures. (Corrugated cardboard packages become weaker as they become wet with water or other liquid. Take care in storage and handling.)
- After unpacking the products, check that they are defect-free and meet the specifications.

(4) Name of parts

BALL CHECK VALVE (Nominal Size: 15-100mm (1/2"-4"))

(Body Material: PVC, C-PVC, PP*1, PVDF*2 / End Connector: Socket End, Threaded End, Flanged End)

*1: Body material PP is only available for Socket End and Threaded End connection.

*2: Body material PVDF is only available for Threaded End connection only.

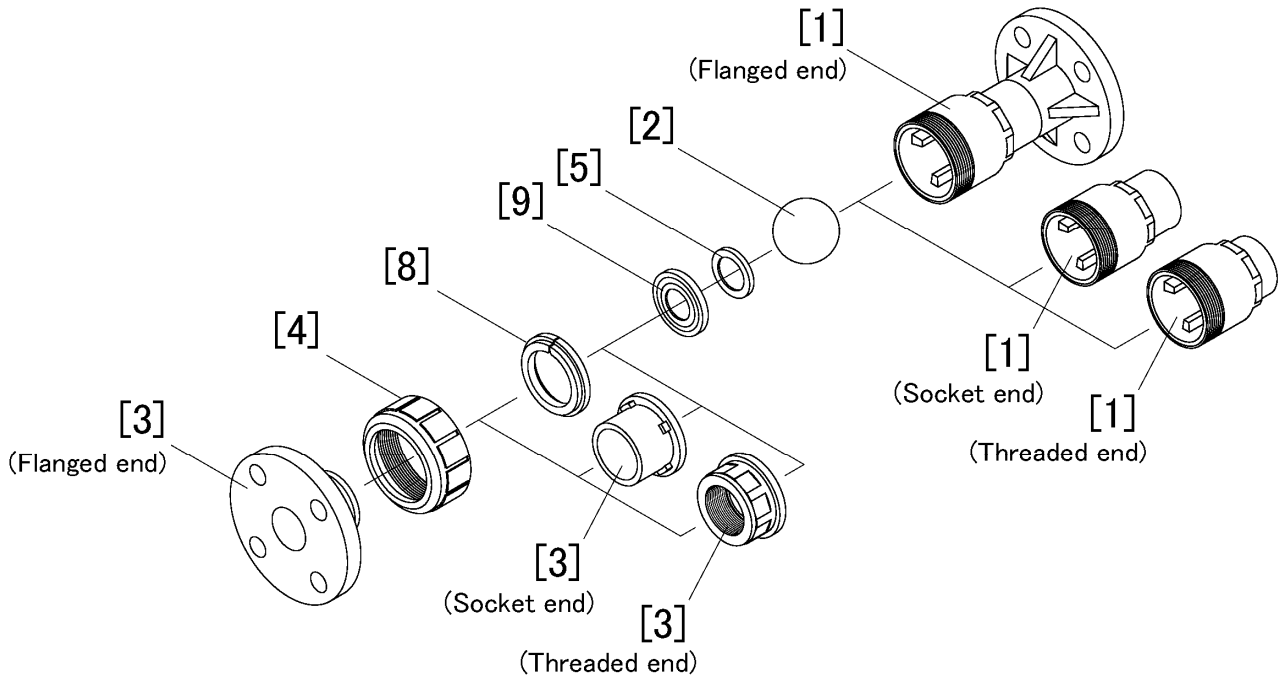

No.	DESCRIPTION
[1]	Body (Flanged end or Socket end or Threaded end)
[2]	Ball
[3]	End connector (Flanged end or Socket end or Threaded end)
[4]	Union nut
[5]	Stop ring (A)
[8]	Stop ring (B) (Used for Flanged end)
[9]	Seat

TRUE UNION BALL CHECK VALVE (Nominal Size: 15-50mm (1/2"-2"))

(Body Material: PVC, C-PVC, PP, PVDF*1 / End Connector: Socket End, Threaded End, Flanged End)

*1: Body material PVDF is only available for Threaded End and Flanged End connection.

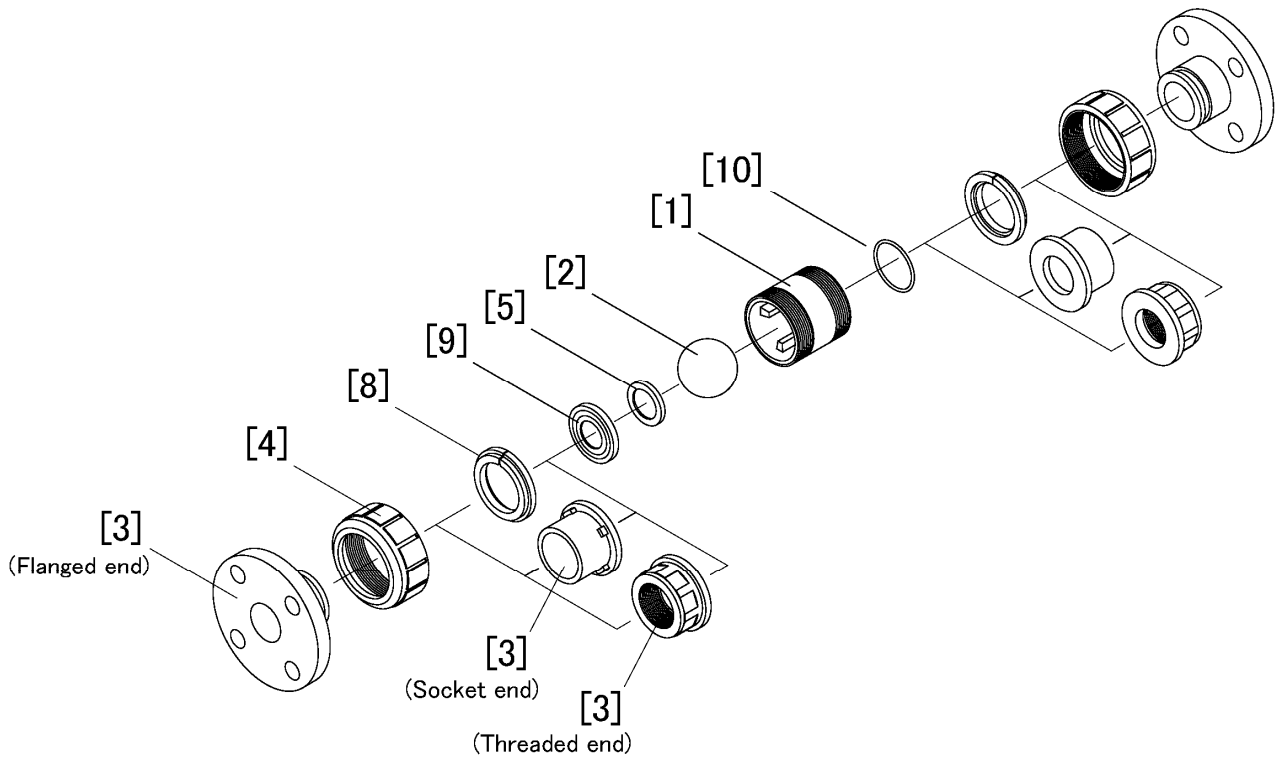

No.	DESCRIPTION
[1]	Body
[2]	Ball
[3]	End connector (Flanged end or Socket end or Threaded end)
[4]	Union nut
[5]	Stop ring (A)
[8]	Stop ring (B) (Used for Flanged end)
[9]	Seat
[10]	O-ring

BALL FOOT VALVE (Nominal Size: 15-100mm (1/2"-4"))

(Body Material: PVC, C-PVC, PP*1, PVDF*2 / End Connector: Socket End, Threaded End, Flanged End)

*1: Body material PP is only available for Socket End and Threaded End connection.

*2: Body material PVDF is only available for Threaded End connection only.

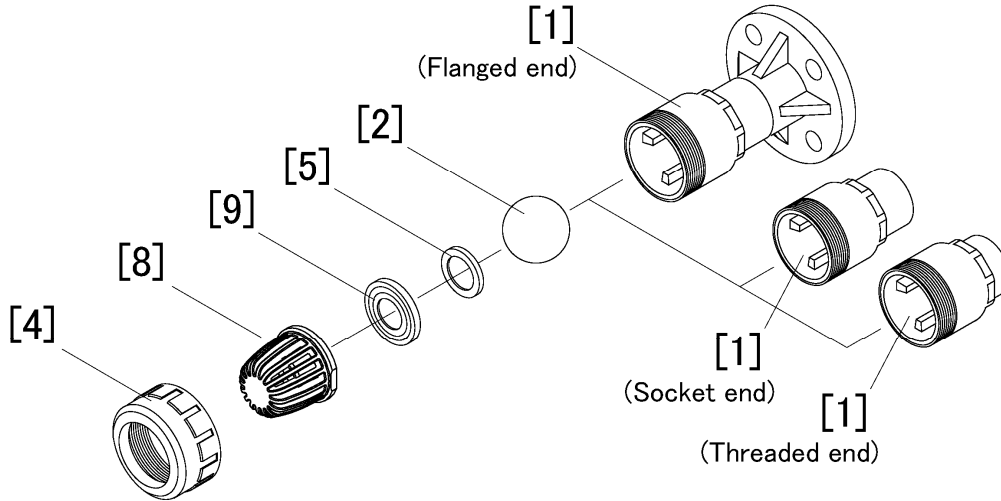

No.	DESCRIPTION
[1]	Body (Flanged end or Socket end or Threaded end)
[2]	Ball
[4]	Union Nut
[5]	Stop Ring (A)
[8]	Screen
[9]	Seat

(5) Working pressure vs. temperature

Nominal size: 15-50mm (1/2"-2")

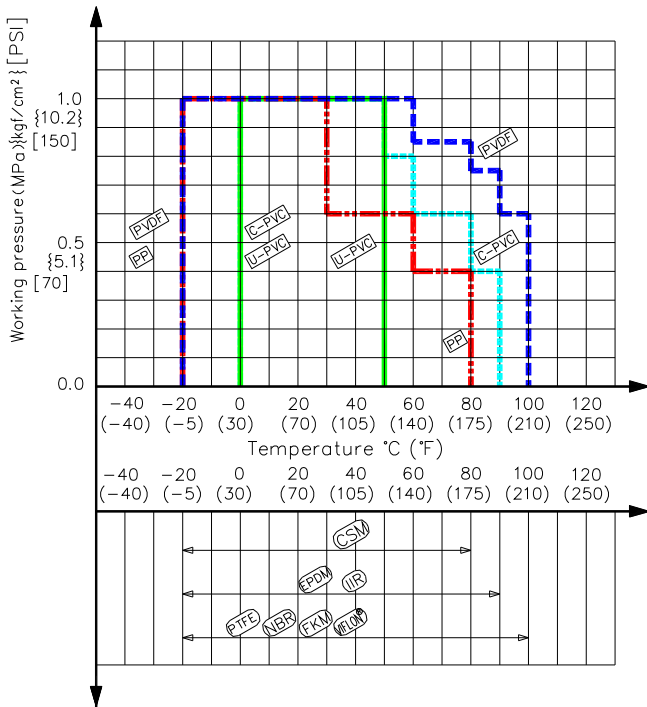

Nominal size: 80, 100mm (3", 4")

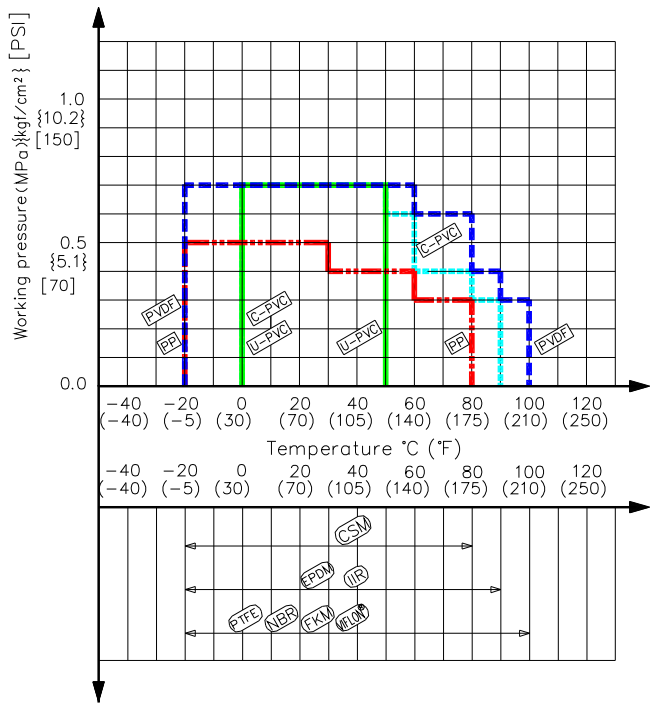

The measurement of the minimum pressure for opening & closing the valve

Unit: MPa [kgf/cm²] [PSI]

Test Items		Vertical Piping		Horizontal Piping	
Nominal Size		Min. Air Pressure to open the valve	Min. Air Pressure to shut the Disc perfectly	Min. Air Pressure to open the valve	Min. Air Pressure to shut the Disc perfectly
mm	inch				
15	1/2	0.005 {0.05} [0.73]	0.02 {0.2} [2.90]	0.001 {0.01} [0.15]	0.02 {0.2} [2.90]
20	3/4	0.005 {0.05} [0.73]	0.03 {0.3} [4.35]	0.001 {0.01} [0.15]	0.03 {0.3} [4.35]
25	1	0.005 {0.05} [0.73]	0.03 {0.3} [4.35]	0.001 {0.01} [0.15]	0.03 {0.3} [4.35]
40	1 1/2	0.01 {0.1} [1.45]	0.03 {0.3} [4.35]	0.002 {0.02} [0.29]	0.03 {0.3} [4.35]
50	2	0.01 {0.1} [1.45]	0.03 {0.3} [4.35]	0.002 {0.02} [0.29]	0.03 {0.3} [4.35]
80	3	0.01 {0.1} [1.45]	0.02 {0.2} [2.90]	0.002 {0.02} [0.29]	0.02 {0.2} [2.90]
100	4	0.01 {0.1} [1.45]	0.02 {0.2} [2.90]	0.002 {0.02} [0.29]	0.02 {0.2} [2.90]

*Data mentioned in the table above is reference only.

(6) Installation procedure

Caution ⚠️

- Take care not to over-tighten the Union Nut. (The valve can be damaged.)
- Do not use the pipe wrench. (The valve can be damaged.)
- The valve is applicable to both types: vertical and horizontal piping. In the case of vertical piping, use the valve in applications where the fluid travels upwards.
- Install the piping while matching the arrow on the valve body with the flow direction of the fluid.

Flanged end (Body Material: PVC, C-PVC, PP, PVDF)

Caution ⚠️

- Use flat faced flanges for connection to AV Valves.
- Ensure that the mating flanges are of the same standards.
- Be sure to use sealing gaskets (AV Gasket), bolts, nuts, and washers and tighten them to specified torques. (When a non-AV gasket is used, a different tightening torque specification should be followed.)

Necessary items

- Torque wrench
- Spanner wrench
- Bolt, Nut, Washer (For many flanges specification)
- AV gasket
- Strap wrench

Procedure

- 1) Set the AV gasket between the flanges.
- 2) Insert washers and bolts from the pipe side, insert washers and nuts from the valve side, then temporarily tighten them by hand.

Caution ⚠️

- The parallelism and axial misalignment of the flange surface should be under the values shown in the following table to prevent damage the valve. (Axial misalignment) (Parallelism)
 (A failure to observe them can cause destruction due to stress application to the pipe)

Unit : mm [inch]

Nom. Size	Axial Misalignment	Parallelism (a-b)
15-25mm (1/2"-1")	1.0 (0.04)	0.5 (0.02)
40,50mm (1 1/2",2")	1.0 (0.04)	0.8 (0.03)
80,100mm (3",4")	1.0 (0.04)	1.0 (0.04)

- 3) Using a torque wrench, tighten the bolts and nuts gradually to the specified torque in a diagonal manner



- Tighten the bolts and nuts gradually with a torque wrench to the specified torque level in a diagonal manner.

Fig.1

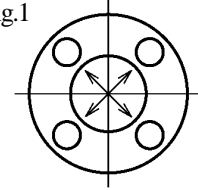

Recommended torque value		Unit: N·m {kgf·cm} [lb·inch]		
Nom. Size	15, 20mm (1/2", 3/4")	25, 40mm (1", 1 1/2")	50 mm (2")	80, 100 mm (3", 4")
PTFE·PVDF coated	17.5 {179} [155]	20.0 {204} [177]	22.5 {230} [230]	30.0 {306} [266]
Rubber	8.0 {82} [71]	20.0 {204} [177]	22.5 {230} [230]	30.0 {306} [266]

*Be sure to set the union nut [4] when it was removed or loosen from body [1].

- 1) Attach ball [2], stop ring (A) [5] and seat [9] in order, and tighten the union nut [4] by hand.
- 2) Using a strap wrench, screw union nut [4] in by turning from 90° to 180° carefully without damaging it.

Threaded end (Body Material: PVC, C-PVC, PP, PVDF)



- Avoid excessive tightening. (The valve can be damaged.)



- Make sure that the threaded connections are plastic x plastic. (Metallic thread can cause damage.)
- Wrap the threaded joints on our plastic piping with sealing tape. Using a liquid sealing agent or liquid gasket may cause stress cracks (Environmental Stress Cracking). Our product warranty shall not apply in case of said use, even when said use is unavoidable.

Necessary items

- Sealing tape
- Strap wrench
- Spanner wrench

Example: Installation procedure of the end connector (on the seat side) of ball check valve.

Procedure

- 1) Wind a sealing tape around the external thread of joint, leaving the end (about 3mm) free.
- 2) Loosen the union nut [4] with a strap wrench.
- 3) Remove the union nut [4] and the end connector [3].
- 4) Tighten the external thread of the joint and the end connector [3] hardly with hand.
- 5) Using a spanner wrench, screw in the end connector [3] by turning 180° -360° carefully without damaging it.
- 6) Make sure that the ball [2], stop ring (A) [5] and seat [9] are set.
- 7) Set the end connector [3] and union nut [4] directly on the body.
- 8) Tighten the union nut [4] hardly with hand.
- 9) Using a strap wrench tighten union nut [4] approx from 90° to 180° turns, 1/4 to 1/2 turns.

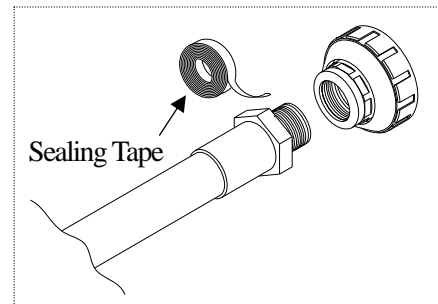

Socket end (Body Material: PVC, C-PVC)

 **Warning**

- When using an adhesive, ventilate the space sufficiently, prohibit the use of a fire in the vicinity, and do not inhale adhesive vapors directly.
- If an adhesive gets into contact with your skin, wash it off immediately. If you feel sick or find any anomaly, receive a physician's diagnosis and take appropriate measures promptly.

 **Caution**

- Take care in doing work at low temperatures. Solvent vapors are hard to evaporate and are likely to remain. (Solvent cracks may occur, damaging the equipment.) After assembling the piping system, open both ends of the piping and use a fan (of the Low-Voltage Type) or something similar to ventilate the space, thus removing the solvent vapors.

 **!**

- Use the appropriate Asahi AV cement.
- Conduct a water test at least 24 hours after joining the pipes with an adhesive/cement.

Necessary items

- Adhesive for hard vinyl chloride pipes
- Strap wrench

Example: Installation procedure of the end connector (on the seat side) of ball check valve.

Procedure

- 1) Loosen the union nut [4] with a strap wrench.
- 2) Remove the union nut [4] and end connector [3].
- 3) Lead the union nut [4] through the pipe.
- 4) Clean the hub part of the end connector [3] by wiping the waste cloth.
- 5) Apply adhesive evenly to the hub part of the end connector [3] and the pipe spigot.

 **Caution**

- Do not apply more adhesive than necessary. (The valve can be damaged due to solvent cracking.)

Adhesive quantity (guideline)

Nom. Size	15mm (1/2")	20mm (3/4")	25mm (1")	40 (1 1/2")	50 (2")	80 (3")	100 (4")
Quantity(g)	1.0	1.3	2.0	3.5	4.8	9.0	13.0

- 6) After applying adhesive, insert the pipe quickly to the end connector [3] and leave it alone for at least 60 seconds.

 **Caution**

- Do not try to insert a pipe into another fitting or valve by striking it under any circumstances, which may break the piping.

- 7) Wipe away overflowing adhesive.
- 8) Make sure that the ball [2], stop ring (A) [5] and seat [9] are set.
- 9) Set the end connector [3] and union nut [4] directly on the body.
- 10) Tighten the union nut [4] hardly with hand.
- 11) Using a strap wrench tighten union nut [4] approx from 90° to 180° turns, 1/4 to 1/2 turns.

Socket end (Body Material: PP)

Necessary items



- Strap wrench
- Sleeve welder or automatic welding machine
- User's manual for sleeve welder or automatic welding machine

Example: Installation procedure of the end connector (on the seat side) of ball check valve.



Procedure

- 1) Loosen the union nut [4] with a strap wrench.
- 2) Remove the union nut [4] and the end connector [3].
- 3) Lead the union nut [4] through the pipe.
- 4) For the next step, refer to the user's manual for the sleeve welder or the automatic welding machine.
- 5) After welding, make sure that the ball [2], stop ring (A) [5] and seat [9] are set.
- 6) Set the end connector [3] and the union nut [4] directly on the valve.
- 7) Tighten the union nut [4] hardly with hand.
- 8) Using a strap wrench tighten union nuts [4] approx from 90° to 180° turns, 1/4 to 1/2 turns.

(7) Disassembling Method for Replacing Parts

-   - Be sure to conduct a safety check on all hand and power tools to be used before beginning work.

Warning - Wear protective gloves and safety goggles as fluid remain in the valve even if the pipeline is empty.
(You may be injured.)

  - Do not change or replace valve parts under line pressure.

Caution - Do not use the pipe wrench. (The valve can be damaged.)

 - Be aware of over-tightening the Union Nut. (The valve can be damaged.)

 - When installing, disassembling, or reassembling the piping, fix the End Connector.
 - Before a water test, be sure that the Union Nut is tightly fastened.
 - Fasten the Union Nut while avoiding the parallelism and axial misalignment of the flange surface.
 - When connecting an ASAHI AV Valve to metal piping, take care not to let the pipe stress on the ASAHI AV Valve.

Necessary items

- Strap wrench
- Safety goggles
- Protective gloves

<Disassembly>

Procedure

- 1) Completely discharge fluid from pipes.
- 2) Loosen the union nut [4] on the seat [9] side with a strap wrench.
- 3) Remove the seat [9], stop ring (A) [5] and ball [2].
- 4) **Only for True Union Ball Check Valve**
Loosen the union nut [4] on another side with a strap wrench and remove it.

<Assembly>

Procedure

1) Attach the ball [2], stop ring (A) [5] and seat [9] in order, and tighten the union nut [4] hardly by hand.



Caution

- Check the seat and the stop ring (A) for their faces and backs, and ensure they are installed properly they will not work properly if installed backwards. (They can not be sealed.)

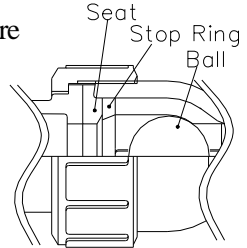

2) Only for True Union Ball Check Valve

Set the end connector [3] directly on the body [1] without allowing the O-ring (A) [10] to come off and tighten the union nut [4] hardly by hand.

3) Using a strap wrench, screw them in by turning from 90° to 180° carefully without damaging them.

(8) Inspection items



Caution

- Perform periodic maintenance. (Leakage may develop due to temperature changes or over periods of prolonged storage, rest or operation.)

○Inspect the follow items;

(1)	Check for any flaw, cracks, or deformation on the outside.
(2)	Check whether fluid leaks to the outside.
(3)	Check whether the cap nut has been loosened.

(9) Troubleshooting

Problem	Cause	Treatment
Fluid leaks from the valve even when the valve is closed fully.	Insufficient back pressure	Check back pressure.
	Foreign matter is in the valve.	Clean the valve.
	The seat or ball is scratched or worn.	Replace the seat or ball with a new one.
Fluid leaks from the valve.	The seat is scratched or worn.	Replace seat with a new one.
	The O-ring is scratched. (True Union Ball Check Valve only)	Replace O-ring a new one.
	The union nut is loosened.	Tighten up the union nut.

(10) Handling of residual and waste materials



Warning

- Make sure to consult a waste treatment dealer for recommendations on the proper disposal of plastic valves. (Poisonous gas is generated when the valve is burned improperly.)

Ball Check Valve
True Union Ball Check Valve
Ball Foot Valve

ASAHI YUKIZAI CORPORATION



Distributor

<http://www.asahi-yukizai.co.jp/en/>

Information in this manual is subject to change without notice.

2016.12